



OpenSees

Open System for Earthquake Engineering Simulation
Pacific Earthquake Engineering Research Center



Force-based Element vs. Displacement-based Element

*Vesna Terzic
UC Berkeley*

December 2011

Agenda

- Introduction
- Theory of force-based element (FBE)
- Theory of displacement-based element (DBE)
- Examples
- Summary and conclusions
- Q & A with web participants

Introduction



- Contrary to concentrated plasticity models (elastic element with rotational springs at element ends) force-based element (FBE) and displacement-based element (DBE) permit spread of plasticity along the element (distributed plasticity models).
- Distributed plasticity models allow yielding to occur at any location along the element, which is especially important in the presence of distributed element loads (girders with high gravity loads).

Introduction

- OpenSees commands for defining FBE and DBE have the same arguments:

```
element forceBeamColumn $eleTag $iNode $jNode $numIntgrPts $secTag $transfTag
```

```
element displacementBeamColumn $eleTag $iNode $jNode $numIntgrPts $secTag $transfTag
```

- However a beam-column element needs to be modeled differently using these two elements to achieve a comparable level of accuracy.
- The intent of this seminar is to show users how to properly model frame elements with both FBE and DBE.
- In order to enhance your understanding of these two elements and to assure their correct application I will present the theory of these two elements and demonstrate their application on two examples.

Transformation of global to basic system

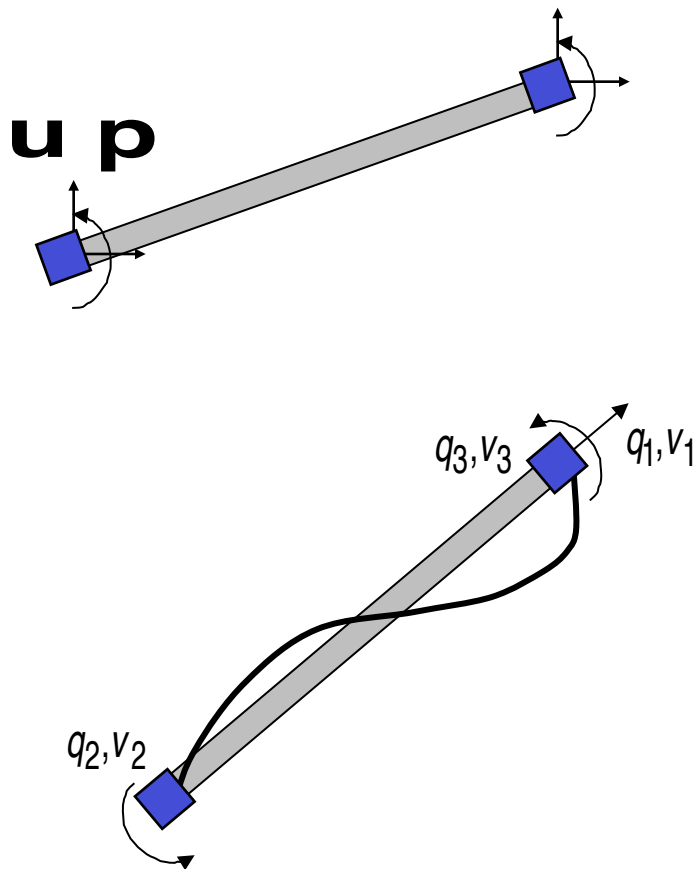

$$\mathbf{v} = \mathbf{a}_f \mathbf{u}$$

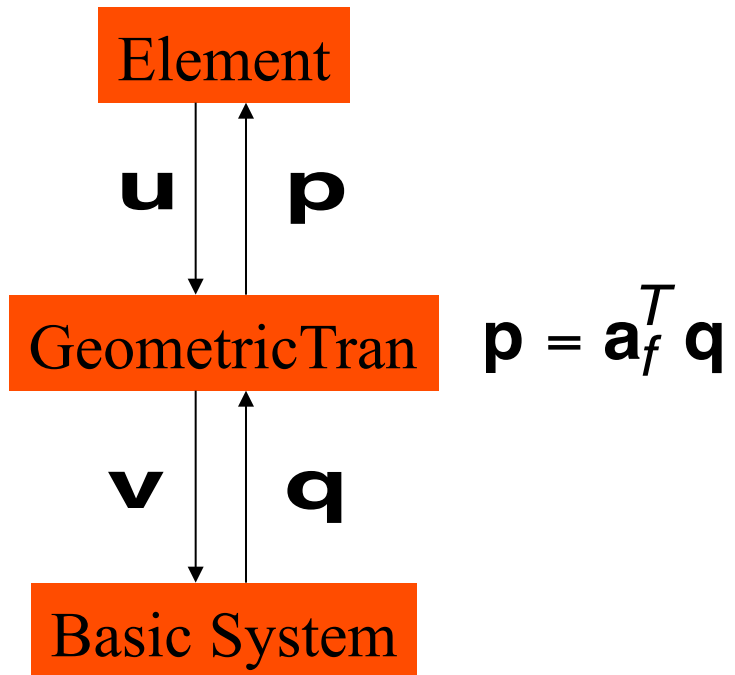

Displacement-based element

- The displacement-based approach follows standard finite element procedures where we interpolate section deformations from an approximate displacement field then use the PVD to form the element equilibrium relationship.
- To approximate nonlinear element response, constant axial deformation and linear curvature distribution are enforced along the element length (exact only for prismatic linear elastic elements)
- Mesh refinement of the element is needed to represent higher order distributions of deformations.

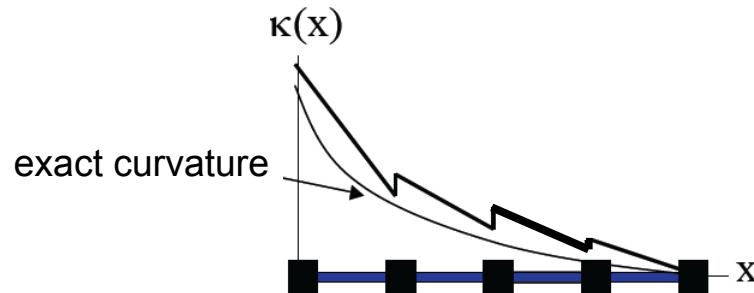

Formulation of DBE (1)

For 2D element:

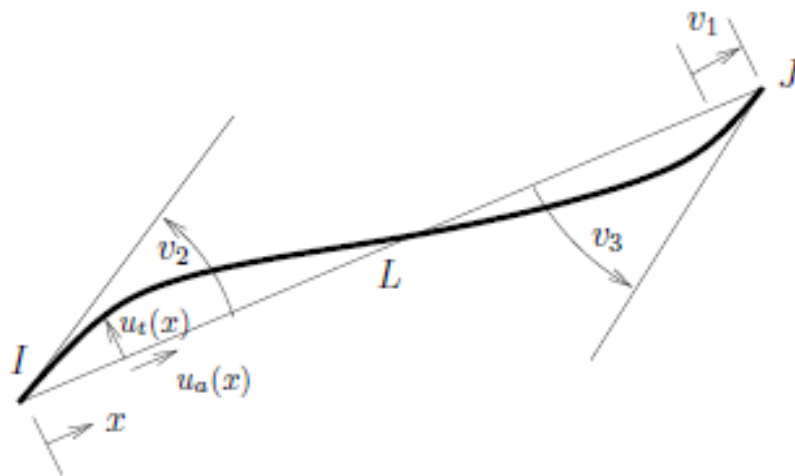

Displacement interpolation:

Assuming constant axial deformation and linear curvature distribution along the element length we get:

$$\xi = x/L$$

$$\begin{bmatrix} u_a(x) \\ u_t(x) \end{bmatrix} = \begin{bmatrix} \xi & 0 & 0 \\ 0 & \xi^3 - 2\xi^2 + \xi & \xi^3 - \xi^2 \end{bmatrix} \begin{bmatrix} v_1 \\ v_2 \\ v_3 \end{bmatrix}$$

$$\begin{bmatrix} u_a(x) \\ u_t(x) \end{bmatrix} = \begin{bmatrix} N_1(x) & 0 & 0 \\ 0 & N_2(x) & N_3(x) \end{bmatrix} \begin{bmatrix} v_1 \\ v_2 \\ v_3 \end{bmatrix}$$

$$\mathbf{u}_e(x) = \mathbf{N}(x)\mathbf{v}$$

$\mathbf{N}(x)$ – matrix of shape functions
(Hermitian polynomials)

Strain-displacement relationship:

$$\varepsilon_a(x) = u'_a(x), \quad \kappa(x) = u''_t(x)$$

$$\begin{bmatrix} \varepsilon_a(x) \\ \kappa(x) \end{bmatrix} = \frac{1}{L} \begin{bmatrix} 1 & 0 & 0 \\ 0 & 6x/L - 4 & 6x/L - 2 \end{bmatrix} \begin{bmatrix} v_1 \\ v_2 \\ v_3 \end{bmatrix}$$

$$\mathbf{e}(x) = \begin{bmatrix} \varepsilon_a(x) \\ \kappa(x) \end{bmatrix} = \mathbf{B}(x)\mathbf{v}$$

Formulation of DBE (2)

Element basic forces:

(PVD is used to formulate equilibrium between $s(x)$ and q)

$$\mathbf{q} = \int_0^L \mathbf{B}^T(x) \mathbf{s}(x) dx \approx \sum_{i=1}^{N_p} \mathbf{B}^T(x_i) \mathbf{s}(x_i) w_i$$

This is “weak equilibrium” that leads to error in force boundary conditions. Thus, internal forces are not in equilibrium with element basic forces.

To assemble tangent stiffness matrix of the system we need to know tangent stiffness matrix of each element:

$$\mathbf{k} \equiv \frac{\partial \mathbf{q}}{\partial \mathbf{v}} = \int_0^L \mathbf{B}^T(x) \mathbf{k}_s(x) \mathbf{B}(x) dx \approx \sum_{i=1}^{N_p} \mathbf{B}^T(x_i) \mathbf{k}_s(x_i) \mathbf{B}(x_i) w_i$$

$$\mathbf{k}_s(x) \equiv \frac{\partial \mathbf{s}}{\partial \mathbf{e}} = \int_A \mathbf{a}_s^T \mathbf{E}_T \mathbf{a}_s dA = \sum_{i=1}^{N_{fiber}} \mathbf{a}_{s_i}^T \mathbf{E}_{T_i} \mathbf{a}_{s_i} A_i \quad \text{- sectional stiffness}$$

$$\mathbf{E}_T \equiv \partial \boldsymbol{\sigma} / \partial \boldsymbol{\varepsilon} \quad \text{- material tangent stiffness}$$

Formulation of DBE (3)

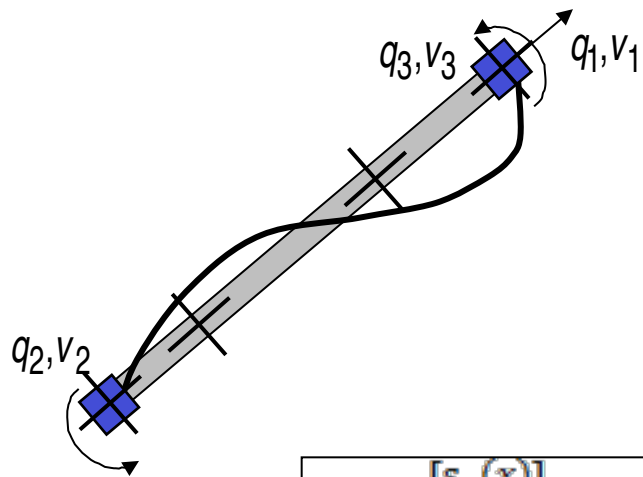

$$\mathbf{e}(x) = \begin{bmatrix} \varepsilon_\alpha(x) \\ \kappa(x) \end{bmatrix} = \mathbf{B}(x)\mathbf{v}$$

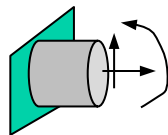

$$\varepsilon_i = \varepsilon_\alpha - y_i \kappa = \begin{bmatrix} 1 & -y_i \end{bmatrix} \begin{bmatrix} \varepsilon_\alpha \\ \kappa \end{bmatrix} = \mathbf{a}_{s_i} \mathbf{e}$$

\mathbf{v} \mathbf{q}

Basic System

$$\mathbf{q} = \int_0^L \mathbf{B}^T(x) \mathbf{s}(x) dx \approx \sum_{t=1}^{N_p} \mathbf{B}^T(x_t) \mathbf{s}(x_t) w_t$$

\mathbf{e} \mathbf{s}

Section

$$\mathbf{s}(x_i) = \begin{bmatrix} N(x_i) \\ M(x_i) \end{bmatrix} = \sum_{i=1}^{N_{fibers}} \mathbf{a}_{s_i}^T \sigma_i A_i$$

ε σ

Material

$$\sigma_i = \sigma(\varepsilon_i)$$

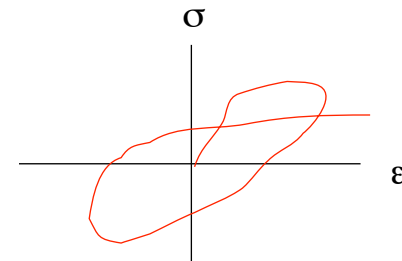

Force-based element

- The force-based approach relies on the availability of an exact equilibrium solution within the basic system of a beam-column element. Equilibrium between element and section forces is exact, which holds in the range of constitutive nonlinearity.
- Section forces are determined from the basic forces by interpolation within the basic system.
 - Interpolation comes from static equilibrium and provides constant axial force and linear distribution of bending moment in the absence of distributed element loads.
- PVF is used to formulate compatibility between section and element deformations:

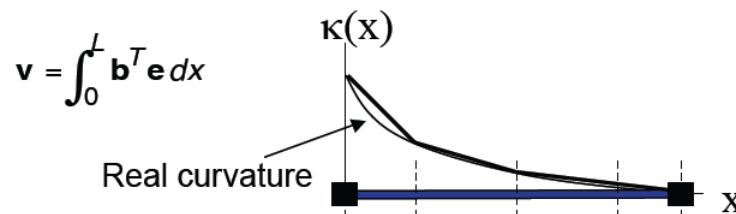

Formulation of FBE

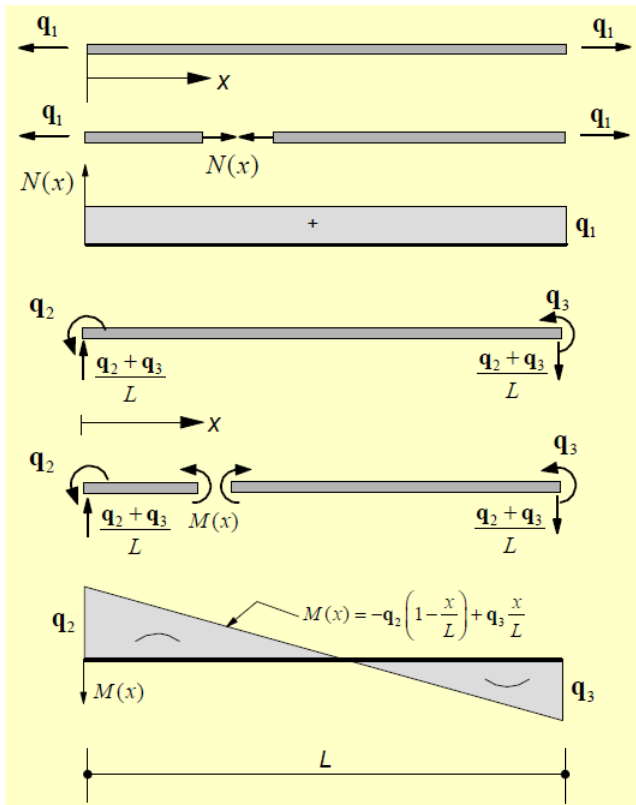

Force interpolation:

From the equilibrium in the undeformed configuration of a free body that comprises the portion of the element between node i and the section at x we get in the absence of element loading:

$$\mathbf{s}(x) = \begin{bmatrix} N(x) \\ M(x) \end{bmatrix} = \begin{bmatrix} 1 & 0 & 0 \\ 0 & -(1-x/L) & x/L \end{bmatrix} \begin{bmatrix} q_1 \\ q_2 \\ q_3 \end{bmatrix}$$

$$\mathbf{s}(x) = \mathbf{b}(x)\mathbf{q}$$

$\mathbf{b}(x)$ – matrix of force interpolation functions

Compatibility between section and element deformation:

(compatibility is satisfied in integral form at the element ends rather than for all values of x and derived using PVF)

$$\mathbf{v} = \int_0^L \mathbf{b}^T(x)\mathbf{e}(x) dx = \sum_{i=1}^{N_p} \mathbf{b}^T(x_i)\mathbf{e}(x_i)w_i$$

Formulation of FBE (2)

To assemble tangent stiffness matrix of the system we need to know tangent stiffness matrix of each element:

$$\mathbf{k} = \mathbf{f}^{-1}$$

Tangent flexibility matrix of element:

$$\mathbf{f} \equiv \frac{\partial \mathbf{v}}{\partial \mathbf{q}} = \int_0^L \mathbf{b}^T(x) \mathbf{f}_s(x) \mathbf{b}(x) dx = \sum_{i=1}^{N_p} \mathbf{b}^T(x_i) \mathbf{f}_s(x_i) \mathbf{b}(x_i) w_i$$

$$\mathbf{f}_s(x_i) = \mathbf{k}_s(x_i)^{-1} \quad - \text{sectional flexibility}$$

Formulation of FBE (3)

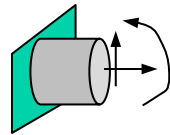
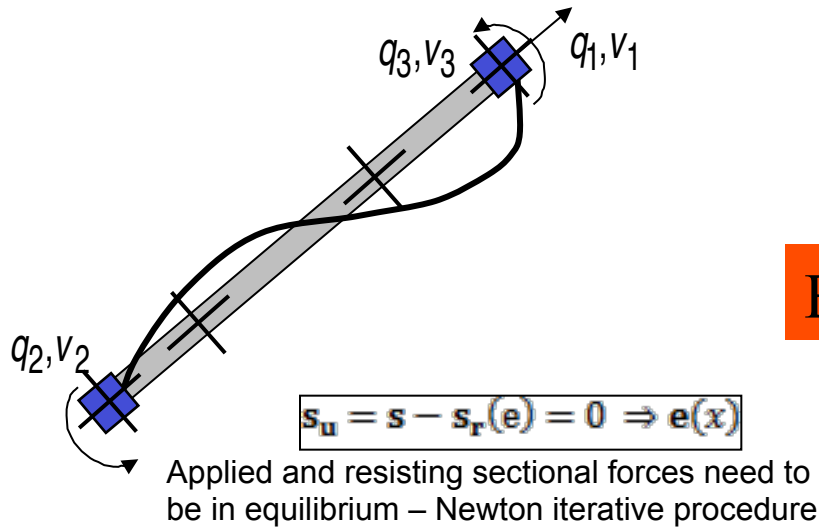

For current e : (we start with the initial guess e_0 and update with $\Delta e = k_s^{-1} s_u$)

$$\varepsilon_i = \varepsilon_\alpha - y_i \kappa = \begin{bmatrix} 1 & -y_i \end{bmatrix} \begin{bmatrix} \varepsilon_\alpha \\ \kappa \end{bmatrix} = a_{s_i} e$$

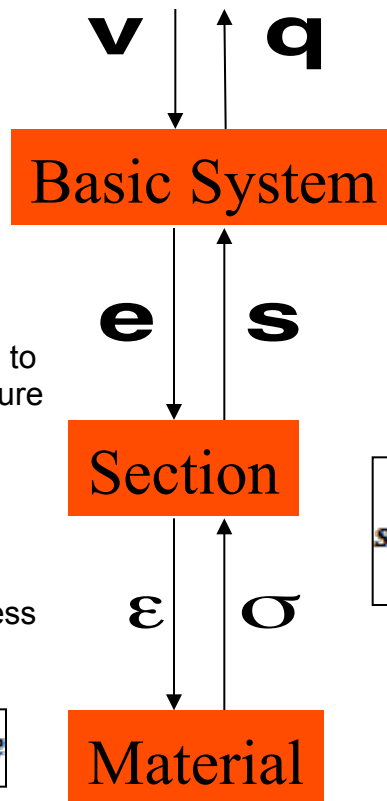

$$v_{res} = v - v_r(q) = 0 \Rightarrow q$$

$$v_r = \sum_{i=1}^{N_p} b^T(x_i) e(x_i) w_i$$

“External” and “internal” element deformations need to be in equilibrium – solved by Newton iterative procedure

For current q : (we start with the initial guess q_0 and update with $\Delta q = f^{-1} v_{res}$)

$$s(x) = b(x)q$$

$$s_f(x_i) = \begin{bmatrix} N(x_i) \\ M(x_i) \end{bmatrix} = \sum_{i=1}^{N_{fibers}} a_{s_i}^T \sigma_i A_i$$

$$\sigma_i = \sigma(\varepsilon_i)$$

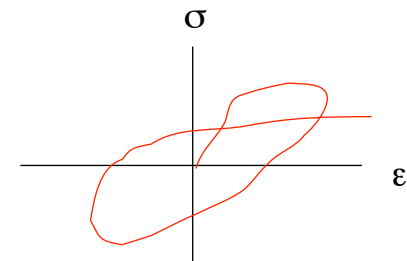

Example 1 – Steel Beam

Neuenhofer, A., and F. C. Filippou, (1997). "Evaluation of Nonlinear Frame Finite Element Models." *Journal of Structural Engineering*, 123(7): 958-966.

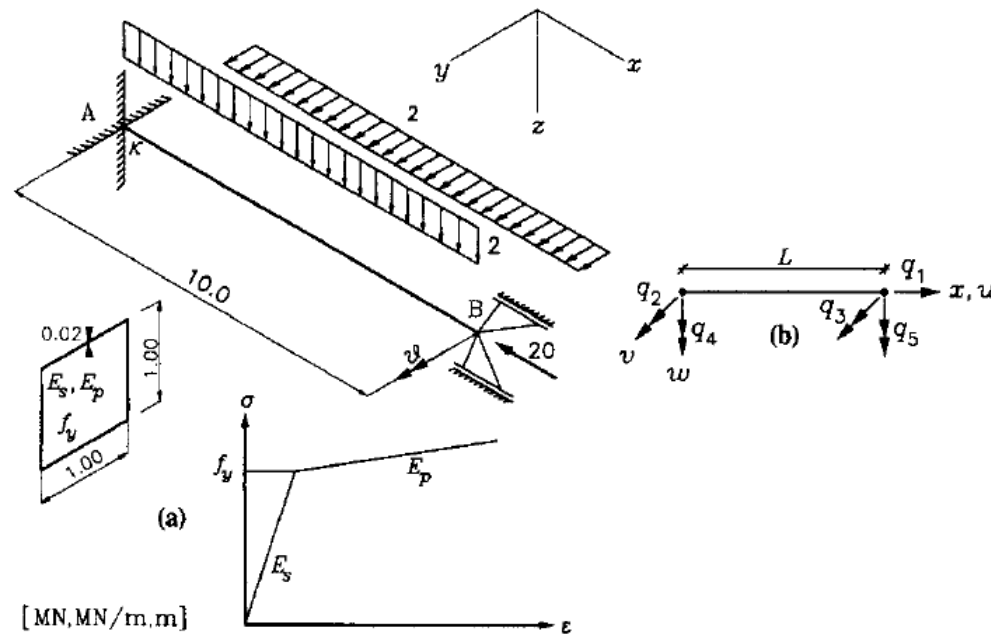

Example 1 – Results

Rotation error (node B)
Global response

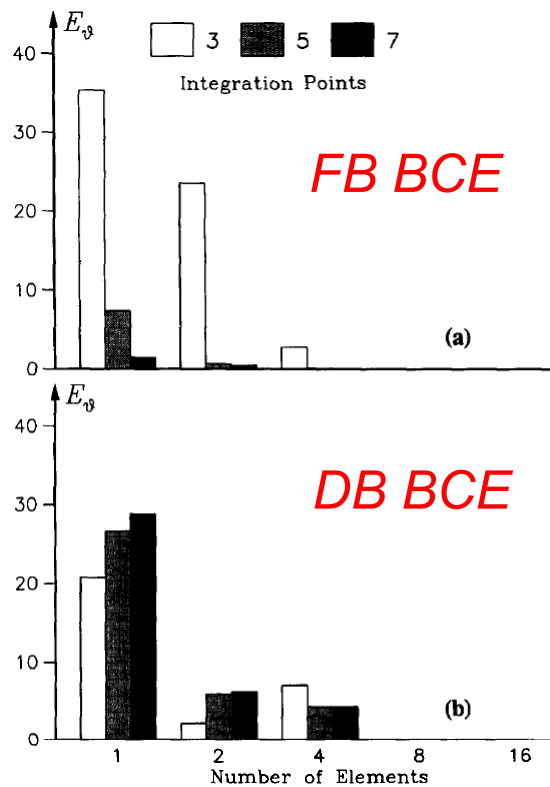

Curvature error (node A)
Local response

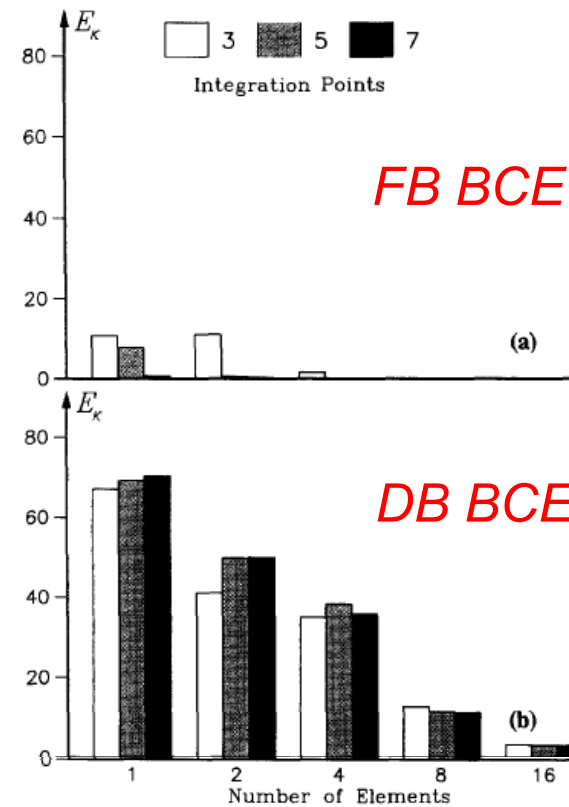

Example 1 – FBE

Rotation error (node B)
Global response

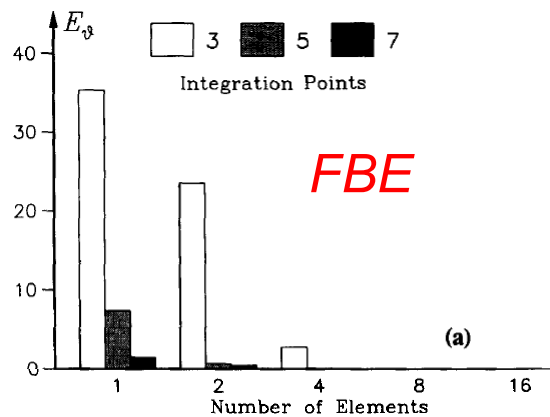

Curvature error (node A)
Local response

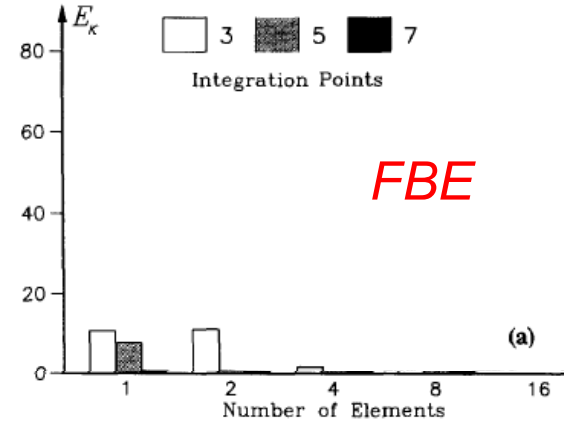

- Accuracy of the solution can be improved by either increasing the NIP (preferable from a computational standpoint) or the number of elements. (This is due to the fact that FBE uses the exact force interpolation functions and thus, does not involve discretization error but only the numerical error.)
- An error less than 2% is obtained for both global and local response quantities with only one element and 7 IPs.

Example 1 – DBE

Rotation error (node B)

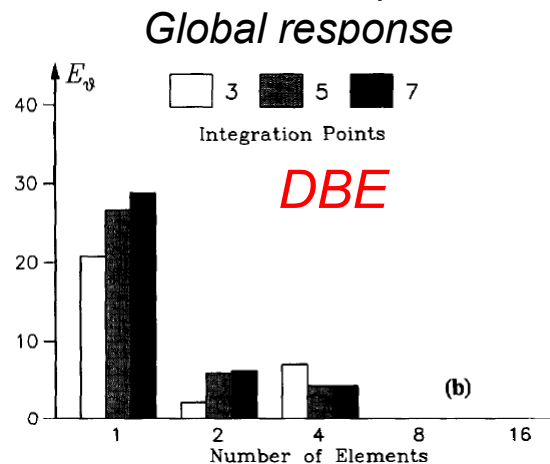

Curvature error (node A)

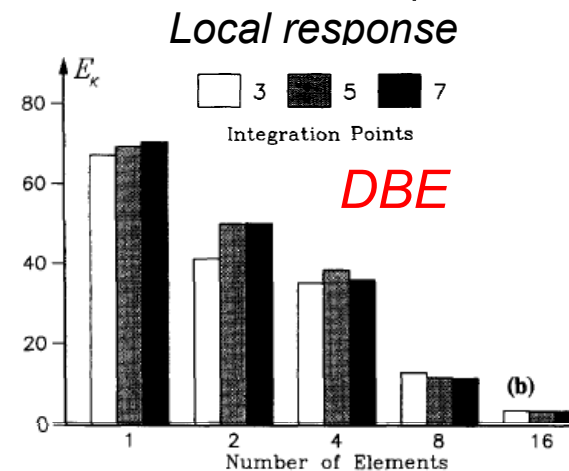

- Accuracy of the solution can only be improved by increasing the number of elements (not by increasing the NIPs). This is due to the fact that DBE uses displacement interpolation functions that approximate the exact solution and thus, involve both discretization and numerical error.
- 8 elements are required to reduce the rotation error to ~ 0 , and 16 elements are required to reduce the curvature error to 3%.

Example 1 - Summary

- Accuracy of the solution can be improved:
 - for FBE, by either increasing the NIPs (preferable from a computational standpoint) or the number of elements,
 - for DBE, only by increasing the number of elements.
- In case of FBE, both local and global quantities converge fast with increasing NIPs.
- In case of DBE, higher derivatives converge slower to the exact solution and thus, accurate determination of local response quantities (e.g., curvature) requires a finer finite-element mesh than the accurate determination of global response quantities (e.g., rotations).

Example 2 – Bridge Column

- Bridge column (Lehman & Moehle, PEER 1998/01 (Column 415))

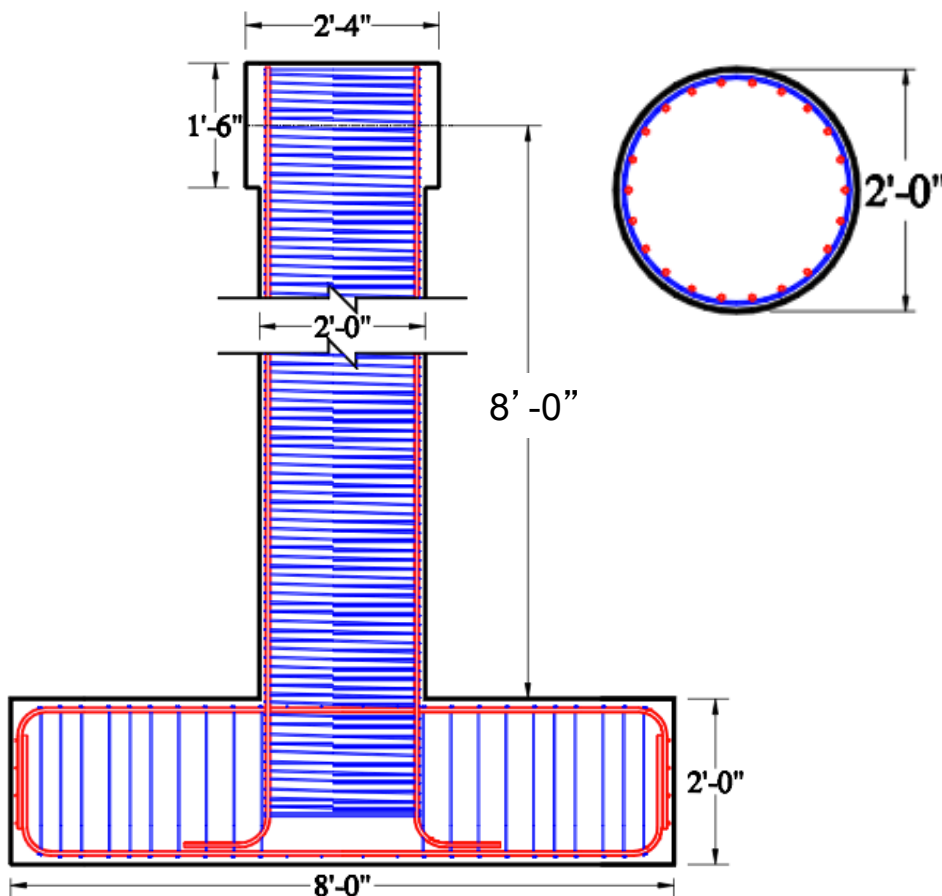

Diameter	24 in.
Height	96 in.
Longitudinal Reinforcement	22#5 Gr60 ($\rho_l=1.5\%$) $f_y=70\text{ksi}$
Transverse Reinforcement	#2@1.25 in. ($\rho_t=0.7\%$) $f_y=96.6\text{ ksi}$
Concrete	$f_c'=4.4\text{ ksi}$

Example 2 - Loading protocol

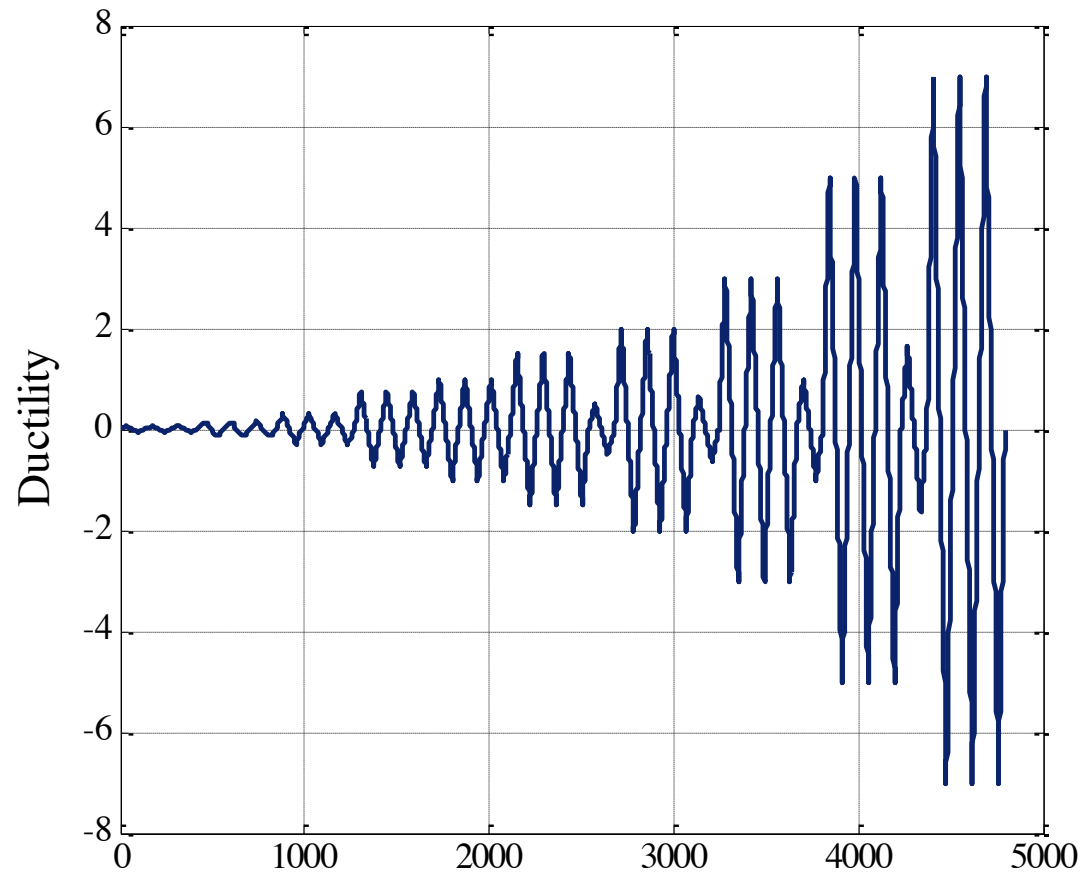

Example 2 – Model calibration

- The column model is calibrated using **force-based element** with 5 integration points. To provide better accuracy of local strains NIPs is chosen such that integration weight of the end node matches the plastic hinge length.

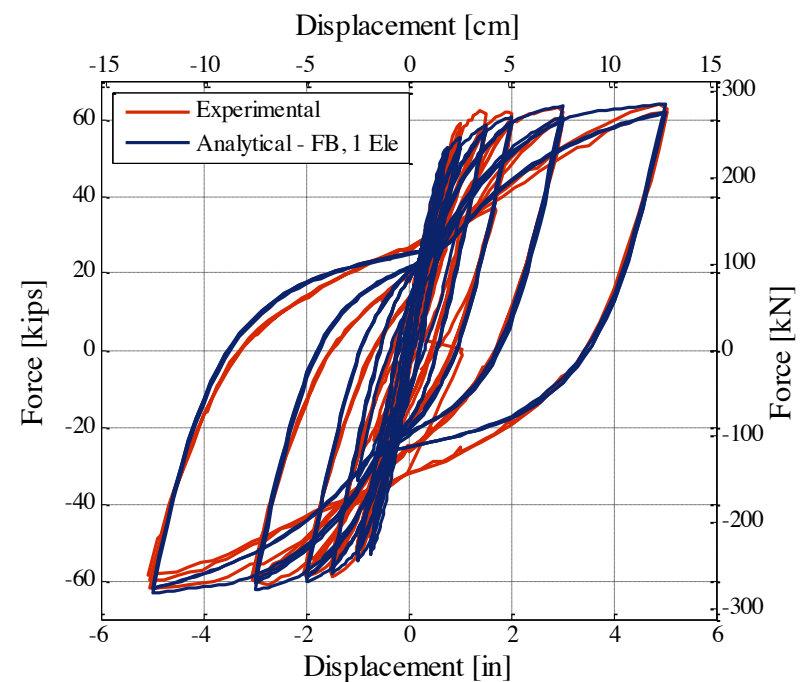
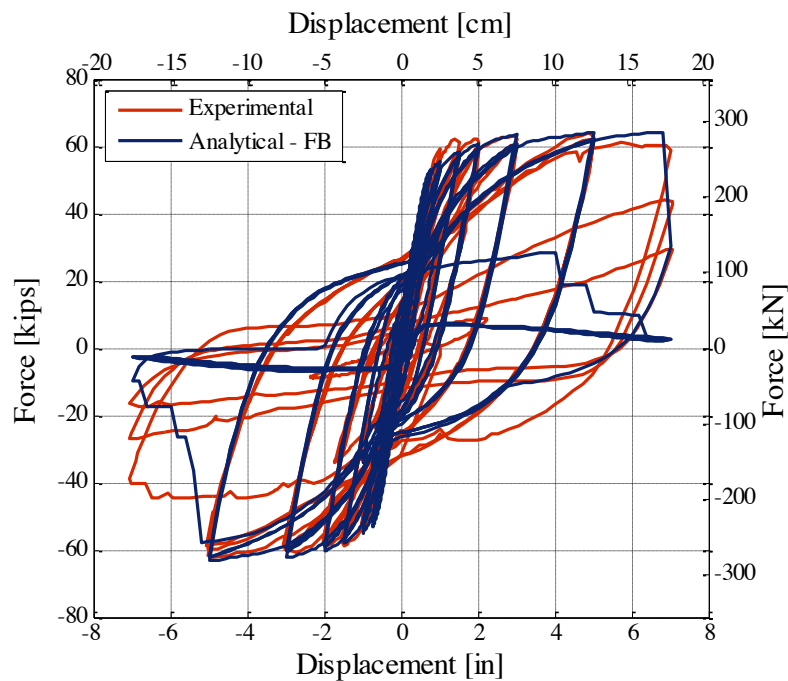

Example 2 – FBE vs. DBE

- The response will change significantly by replacing the force-based beam-column element with the displacement-based beam-column element.

FBE vs. Experiment (NIP = 5)

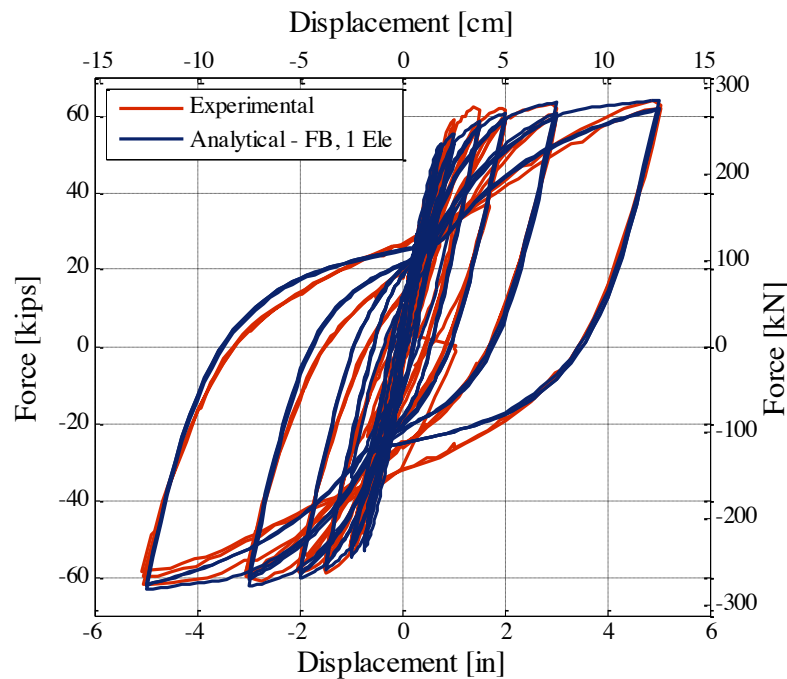

DBE vs. Experiment (NIP = 3)

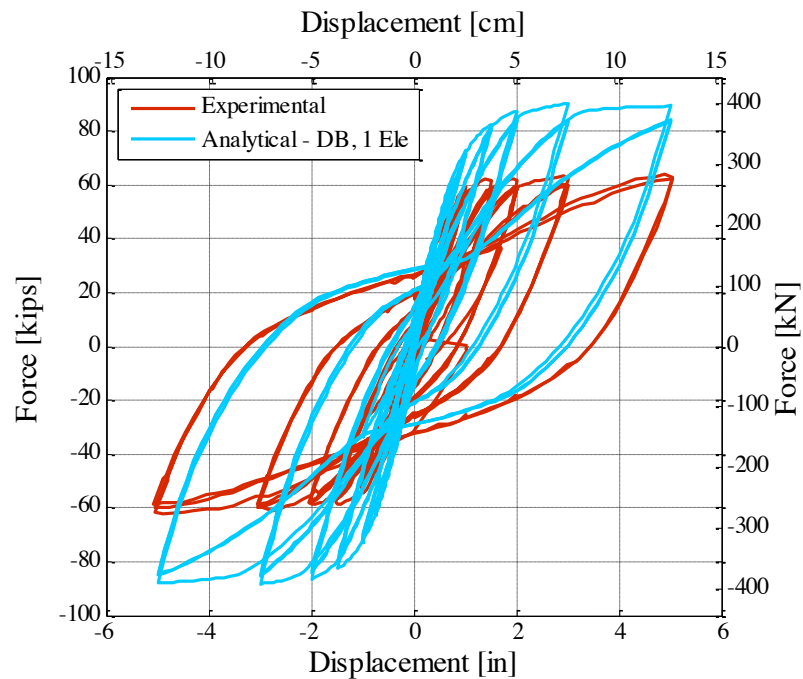

Example 2 - DBE

- With the increase of number of DBE the analytical prediction better matches the measured response of the column.

DBE vs. Experiment
Column modeled with 1 element

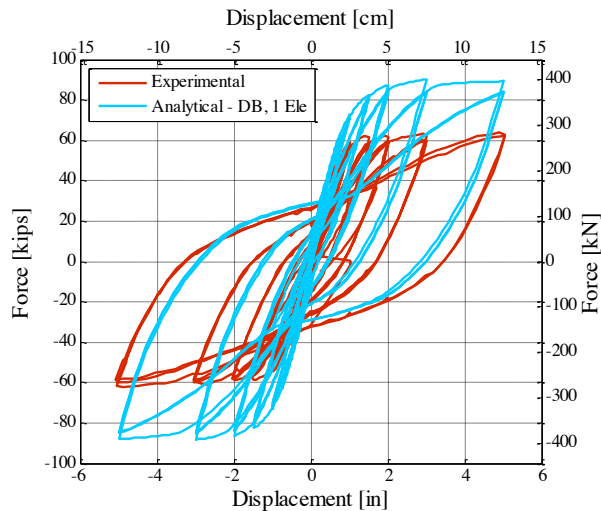

DBE vs. Experiment
Column modeled with 2 elements

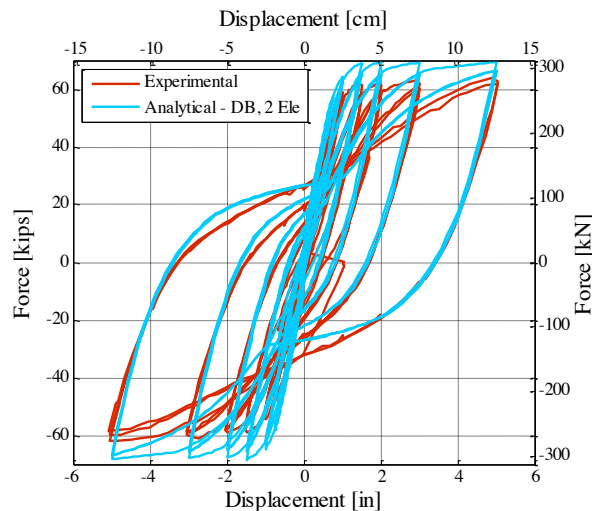

DBE vs. Experiment
Column modeled with 4 elements

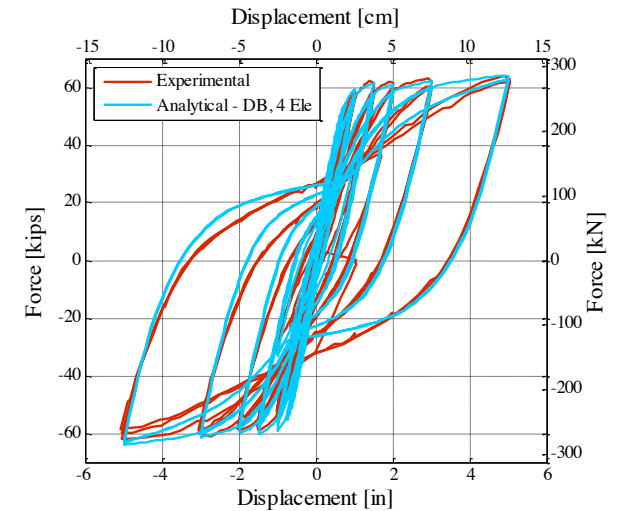

Example 2 - Summary

- To match the measured column response, the column had to be modeled with either **1 FBE** or **4 DBE**.
- Local response quantities could not be compared due to the lack of experimental data. However, it is advisable to use more than 4 DBE when predicting local response quantities.

FBE vs. Experiment

Column modeled with 1 element

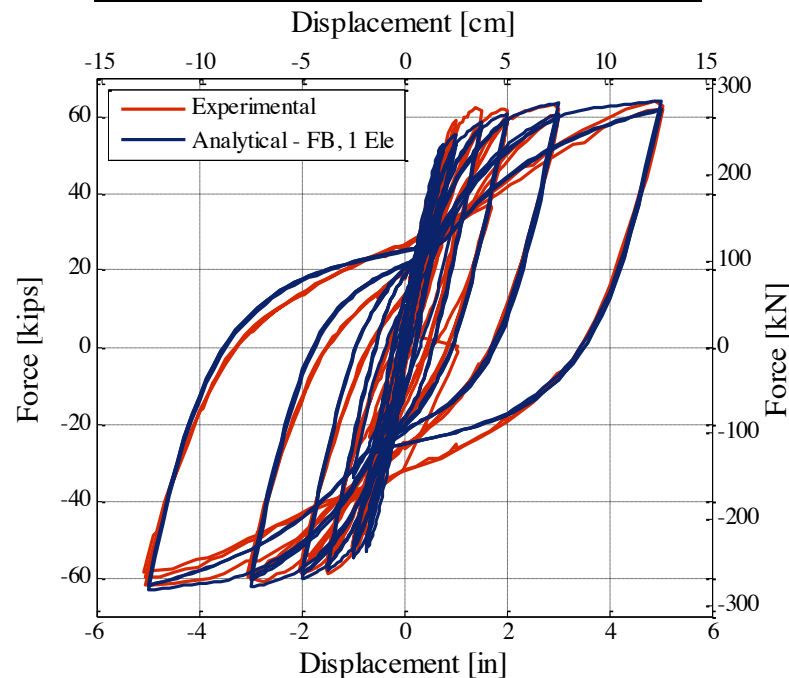

DBE vs. Experiment

Column modeled with 4 elements

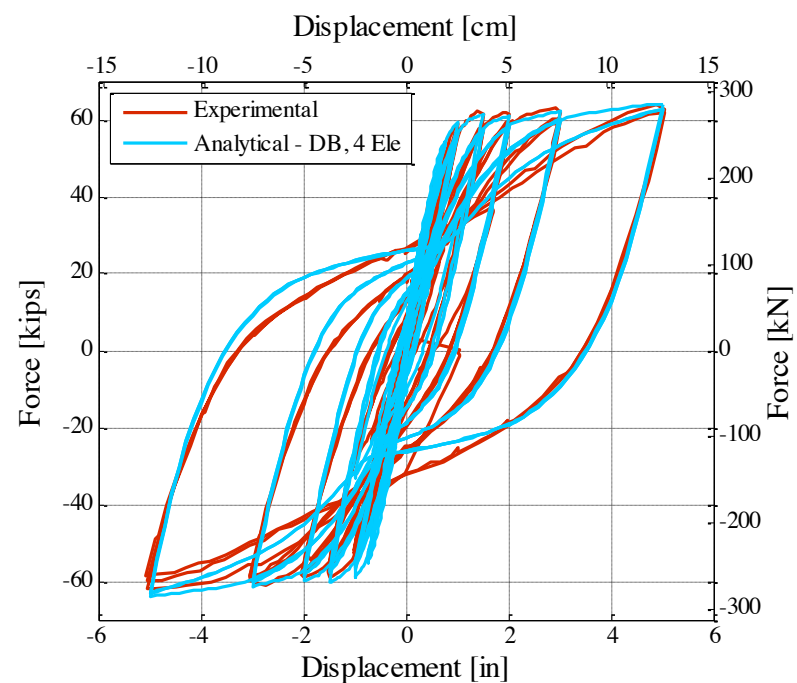

Summary and conclusions

- FBE and DBE can not be modeled in the same way as they inherently differ from each other
- Accuracy of the solution can be improved:
 - for FBE, by either increasing the NIPs (preferable from a computational standpoint) or the number of elements,
 - for DBE, only by increasing the number of elements.
- In case of FBE, both local and global quantities converge fast with increasing NIPs.
- In case of DBE, higher derivatives converge slower to the exact solution and thus, accurate determination of local response quantities requires a finer finite-element mesh than the accurate determination of global response quantities.
- Although computationally more expensive, FBE generally improves global and local response without mesh refinement.
- To accurately capture local response of elements whose plastic hinges locations and lengths can be estimated, NIPs of a FBE has to be chosen such that integration weights at locations of plastic hinges match the plastic hinge lengths.